

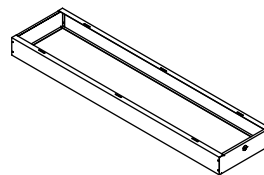

Ceiling Mount Kit 1' x 4'

Product Dimensions



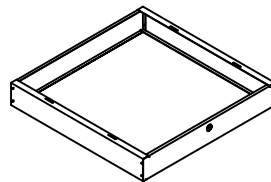
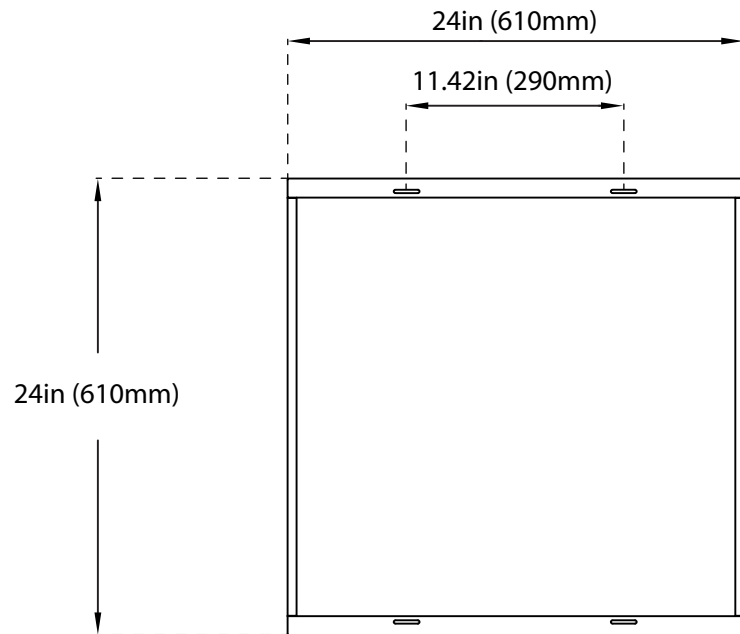
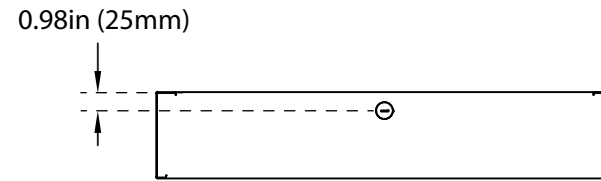
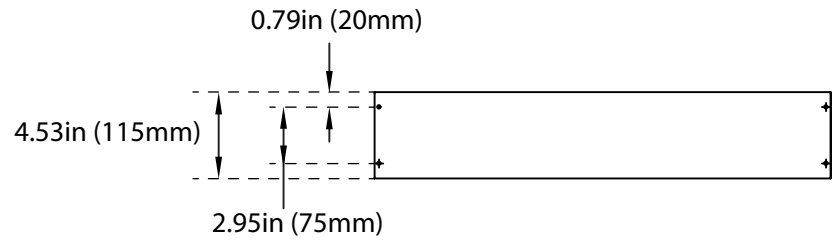

	
SCALE : 1:1	
Measure Tolerance is: ±0.15 mm, ±0.01in	



Ceiling Mount Kit 2' x 2'

Product Dimensions

	
SCALE : 1:1	
Measure Tolerance is: ±0.15 mm, ±0.01in	

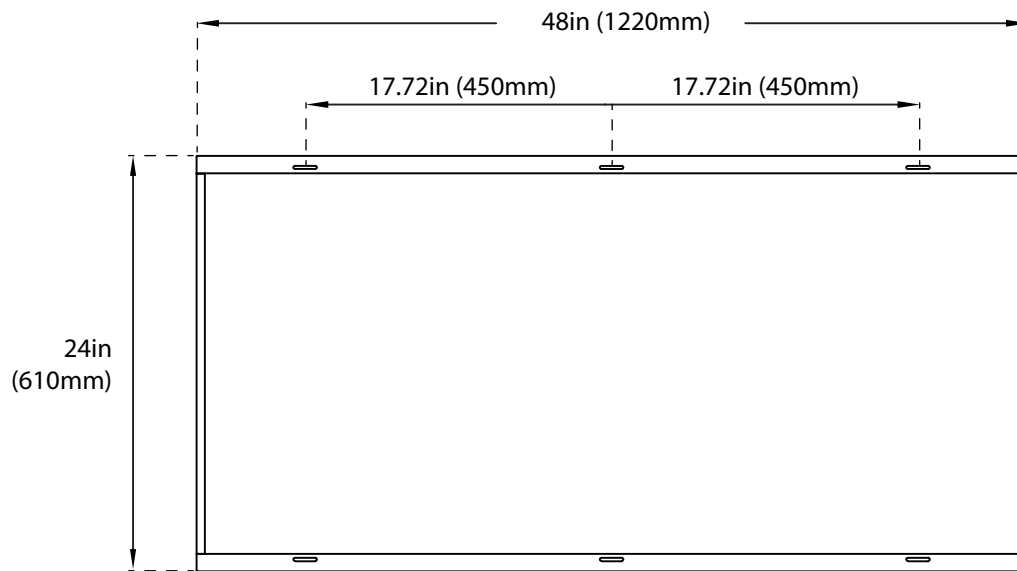
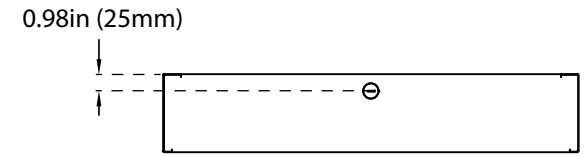
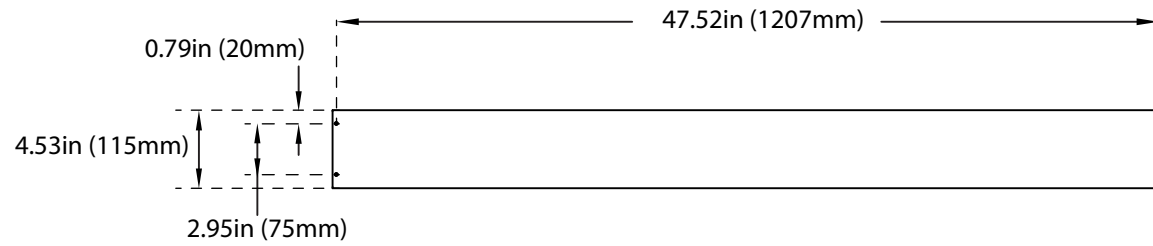

Ceiling Mount Kit 2' x 4'

Product Dimensions

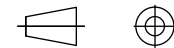
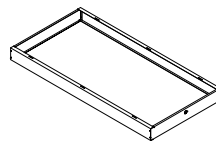

SCALE : 1:1

Measure Tolerance is:
±0.15 mm, ±0.01in